



NTSC U/C

PlayStation™

DESCENT™

MAXIMUM™



Exclusively
for the
PlayStation™
Game Console

An All-New Addiction

TEEN
TM
1
AGES 13+
CONTENT RATED BY
ESRB

SLUS-00460
MN-PSX-444-0

Interplay™
BY GAMERS. FOR GAMERS.™

**WARNING: READ BEFORE USING YOUR PlayStation™
GAME CONSOLE.**

A very small percentage of individuals may experience epileptic seizures when exposed to certain light patterns or flashing lights. Exposure to certain patterns or backgrounds on a television screen or while playing video games, including games played on the PlayStation™ game console, may induce an epileptic seizure in these individuals. Certain conditions may induce previously undetected epileptic symptoms even in persons who have no history of prior seizures or epilepsy. If you, or anyone in your family, has an epileptic condition, consult your physician prior to playing. If you experience any of the following symptoms while playing a video game – dizziness, altered vision, eye or muscle twitches, loss of awareness, disorientation, any involuntary movement, or convulsions – IMMEDIATELY discontinue use and consult your physician before resuming play.

WARNING TO OWNERS OF PROJECTION TELEVISIONS:

Do not connect your PlayStation™ game console to a projection TV without first consulting the user manual for your projection TV, unless it is of the LCD type. Otherwise, it may permanently damage your TV screen.

HANDLING YOUR PlayStation™ DISC:

- This compact disc is intended for use only with the PlayStation™ game console.
- Do not bend it, crush it or submerge it in liquids
- Do not leave it in direct sunlight or near a radiator or other source of heat.
- Be sure to take an occasional rest break during extended play.
- Keep this compact disc clean. Always hold the disc by the edges and keep it in its protective case when not in use. Clean the disc with a lint-free, soft, dry cloth, wiping in straight lines from center to outer edge. Never use solvents or abrasive cleaners.

TABLE OF CONTENTS

PLAYING DESCENT MAXIMUM 4	SETUP 2	CUSTOMER SUPPORT 23	CREDITS 22
CONTROLS 5	OPTIONS 4	LIMITED WARRANTY 24	QUESTIONS AND ANSWERS 21
IN THE MINES 9	SAVING YOUR GAME 19	LINK CABLE OPERATION 20	
MINE CENTERS 11	POWER-UPS 11	IN-GAME OPTIONS 16	

HELIX

85

103

MERCURY
MISSILE

001

5:00

SETUP

Set up your PlayStation™ game console according to the instructions in its Instruction Manual. Make sure the power is off before inserting or removing a compact disc. Insert the Descent Maximum disc and close the disc cover. Insert game controllers and turn on the PlayStation™. Follow on-screen instructions to start a game.

Console

Top View

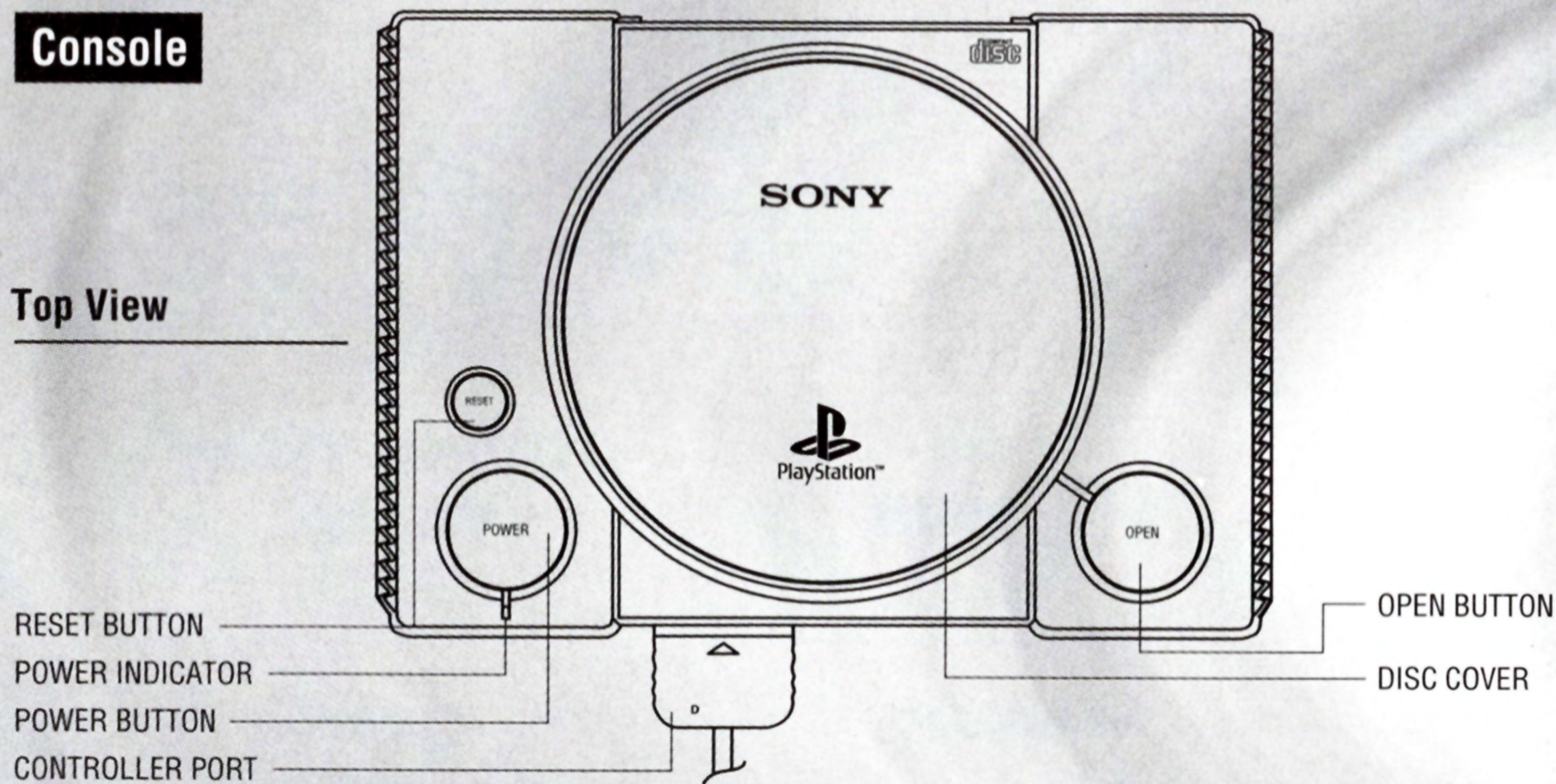

Front View

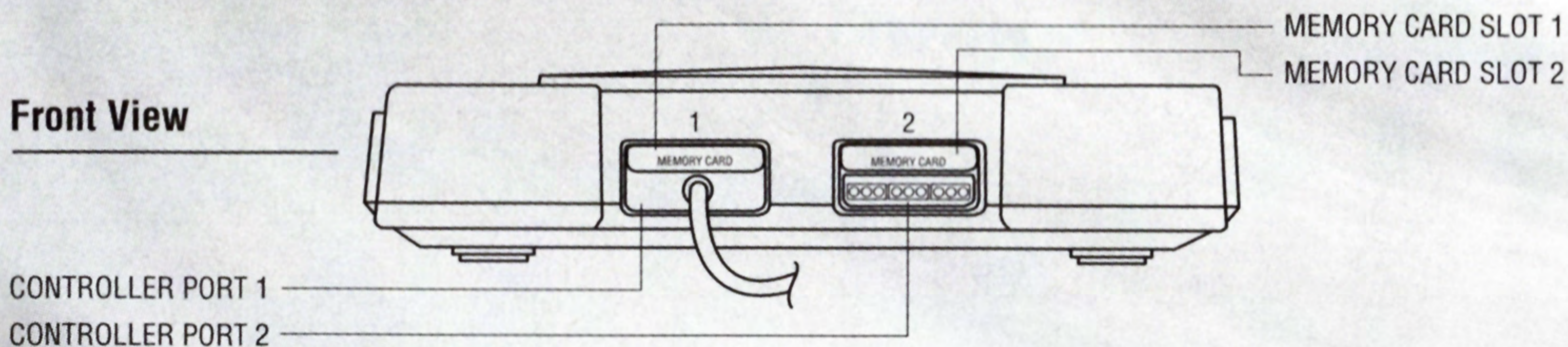

Controller

Front View

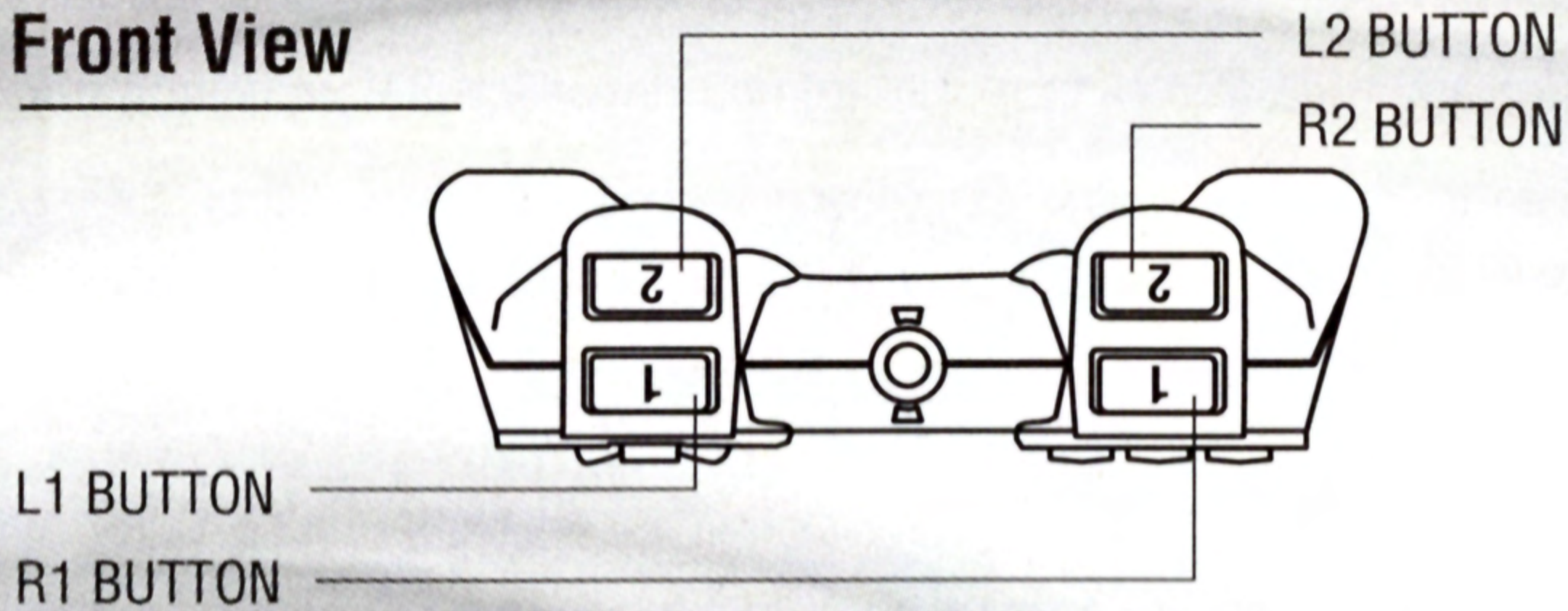

Top View

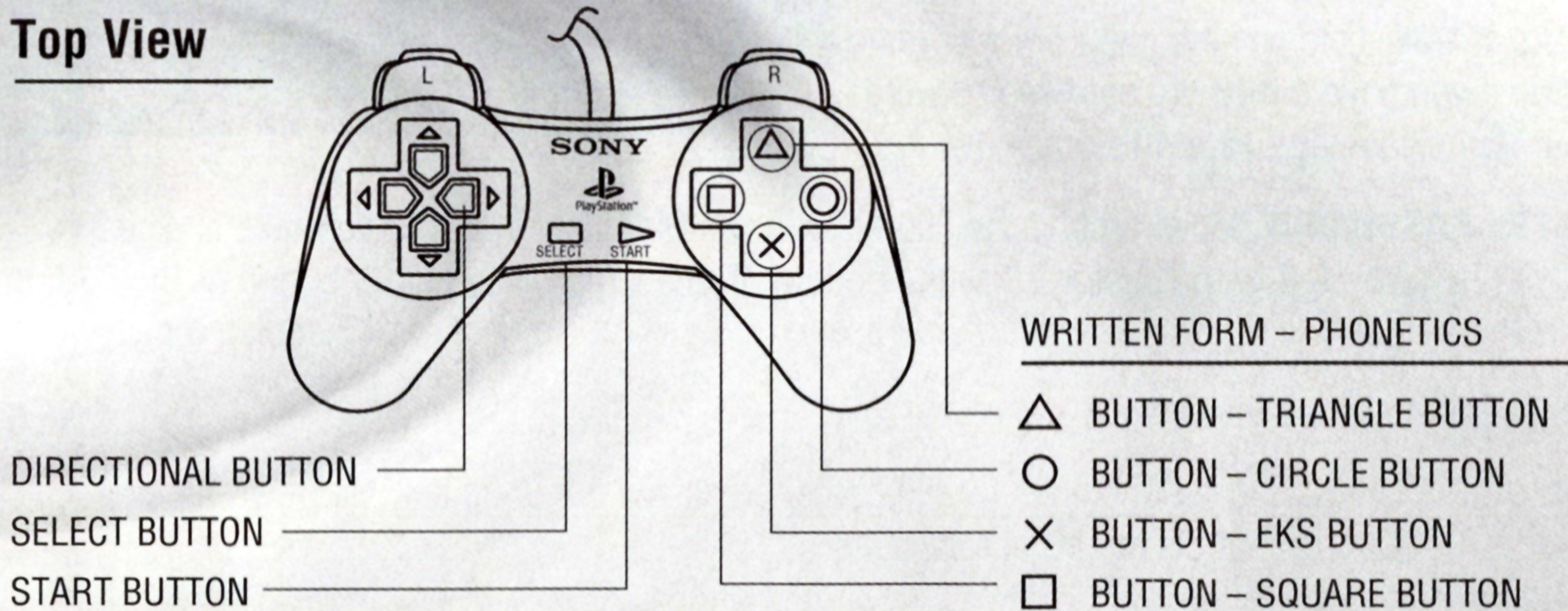

PLAYING DESCENT MAXIMUM

The first screen you will be presented with, after the introductory screens, is the Main Menu. The Main Menu contains a list of options you can choose from. To make selections, use the up/down Directional Buttons, and Press "X" to select any highlighted option.

You can return to this screen at any time in the game by holding down the Select Button and the Start Button for two seconds.

NOTE: This will end your current game, so you might want to save your game to a memory card before returning to the Main Menu screen.

NEW GAME Allows you to start a new game.

COMBAT GAME Opens a menu where you can choose to start or join a two-player game by way of Link Cable.

LOAD GAME Lets you resume from a saved game if you have a memory card see "Saving Your Game" on page 19 of this manual.

ENTER PASSWORD Move around the screen with the Directional Buttons to make choices; to select the next digit in the password at the bottom of the screen, use the button or the button to scroll from left to right. Press "Start" to escape or Press "X" to confirm a completed password.

OPTIONS Activates the Options screen.

CREDITS Displays the list of credits for the game; press any button to exit. Up/Down on the Directional Buttons controls credits scroll speed.

OPTIONS

A red checkmark in the box to the left of an option indicates that it will be activated in your current game; Press "X" to toggle a highlighted option on or off and Press "Start" to exit back to the previous menu. Left/Right on the Directional Buttons toggles options as well.



MUSIC Lets you scale music volume up or down.

FX Allows you to scale sound effects volume up or down.

STEREO Allows you to toggle between stereo and mono sound and music.

FULL SCREEN Lets you toggle between full screen and cockpit mode.

AUTO-LEVELING Automatically aligns your ship to the curvature of the mine tunnels. This is useful to first-time Descent Maximum players, but may be turned off once you're accustomed to full 3D flight.

CONTROL PAD Takes you to the Controls menu. (This option becomes "Analog Joystick..." when an analog joystick is plugged into controller port 1.)

CALIBRATE JOYSTICK Fine-tunes your game control. (This option is only available if you have plugged in a PlayStation™-compatible analog joystick into controller port 1.)

CONTROLS

There are two controllers that Descent Maximum supports on the PlayStation™. One is the "digital" pad that comes with your PlayStation™, and the other is an "analog" joystick that must be purchased separately.

There are two ways to configure these devices; the first and simplest is to select one of the default configurations that we have already set up for you. There are two selections on Controls: Default configuration and User defined.

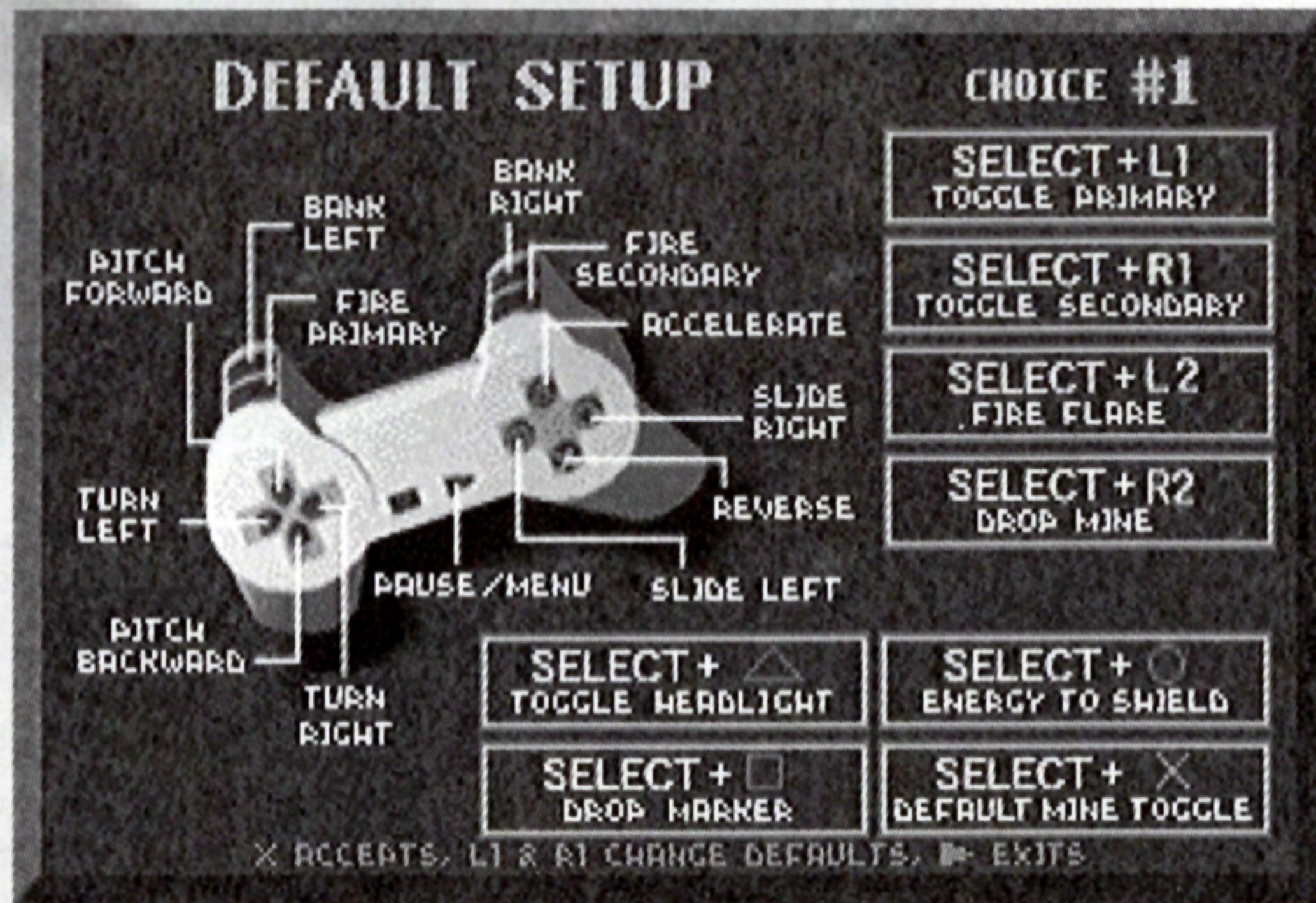

There are four default configurations for the standard controller and one default configuration for the analog joystick. To choose a default setting, select Control Pad from the Options menu (either within the Main Menu or by pressing Start within a game). To select from default options, select Default configuration in the Control Pad menu. The L1 and R1 buttons flip through options; "Start" exits; "X" selects the controller option displayed. The next time you start a level, this choice will be encoded as part of your password. If you have a memory card, it will be saved the next time you save a game.

If the available settings are not to your liking, you can customize your own configuration. Go to

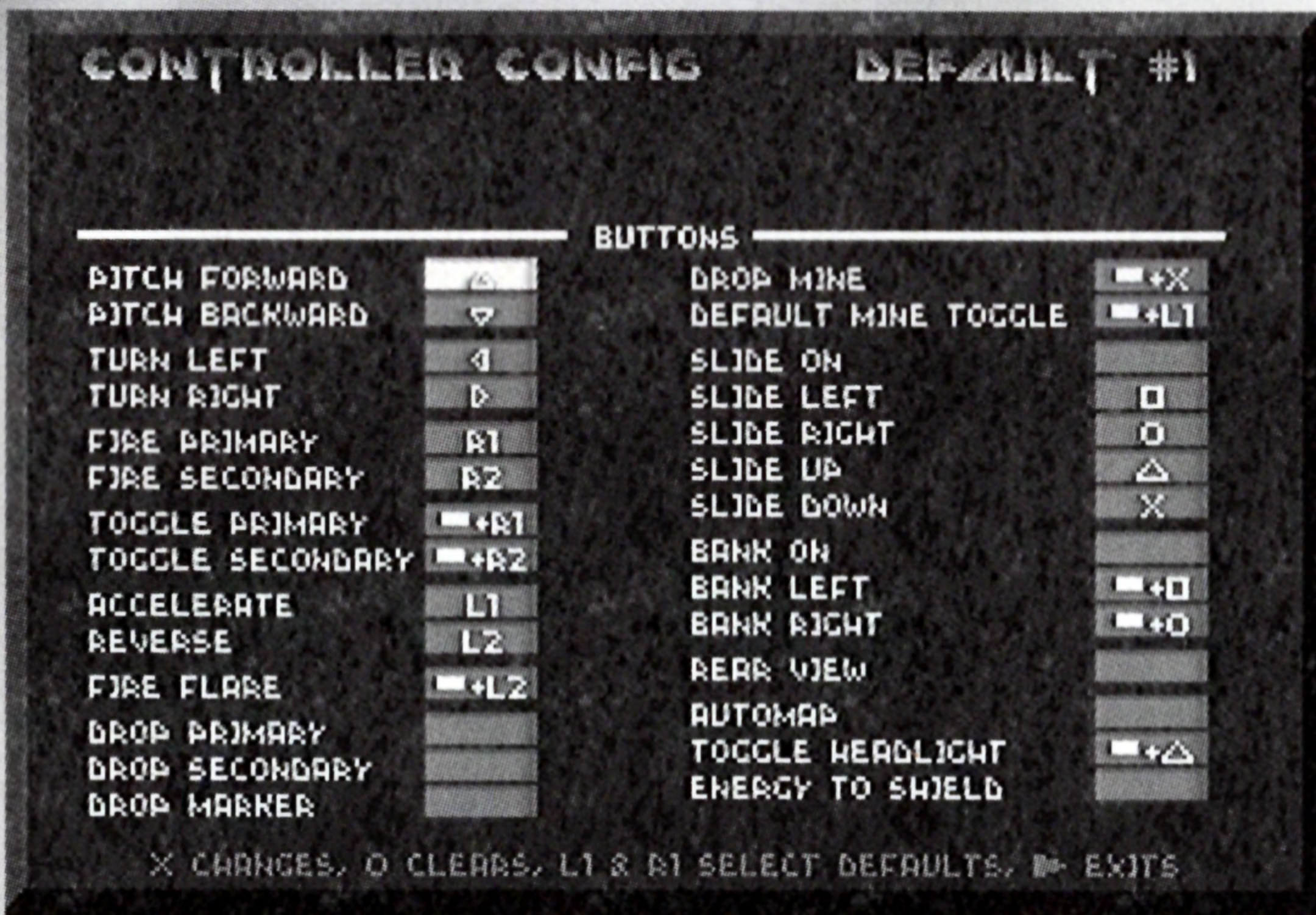

Controls and select User defined. You will see a screen with all the different functions of your ship. Using your Directional Buttons highlight the function you wish to change and press "X" to change it.

The very next button you press will be that setting. (Note: if the selected button was already being used as another command, its former place will become blank and you may need to replace it.) To clear an item so that it doesn't have any buttons associated with

it, move to it using the Directional Buttons and press "○" to clear it. While this method allows more flexibility, it is not always the best choice. For instance, if you don't have a memory card available, you will have to re-enter your configuration every time you start up Descent Maximum. If you use a default configuration, your controller choice is saved in with your password-saved game — see "Saving Your Game" on page 19.

When done defining your layout, press "Start" to exit. The next time you save a game using the memory card, this configuration will be saved. However, if you do not have a memory card and are using a password save, only the default configuration that you started from will be saved with the password.

ANALOG JOYSTICK CALIBRATION

The joystick will need to be calibrated to work properly. To calibrate your joystick:

1. Make sure the analog joystick is plugged into controller port 1 on the PlayStation™.
2. Go into the "Options" menu.
3. You should see a menu item that says "Calibrate Joystick." If you don't see this menu item, make sure the analog joystick is installed properly, and that its mode switch is set to "Analog."
4. Select "Calibrate Joystick." You should then move both sticks to all extremes (this means that you should move the stick to each corner in turn). After you have done this, release the joysticks so they can return to their center position. Then, while making sure the sticks are still in their center position, Press "X" to finish the calibration. When you save a game to the memory card, this calibration information will be saved.

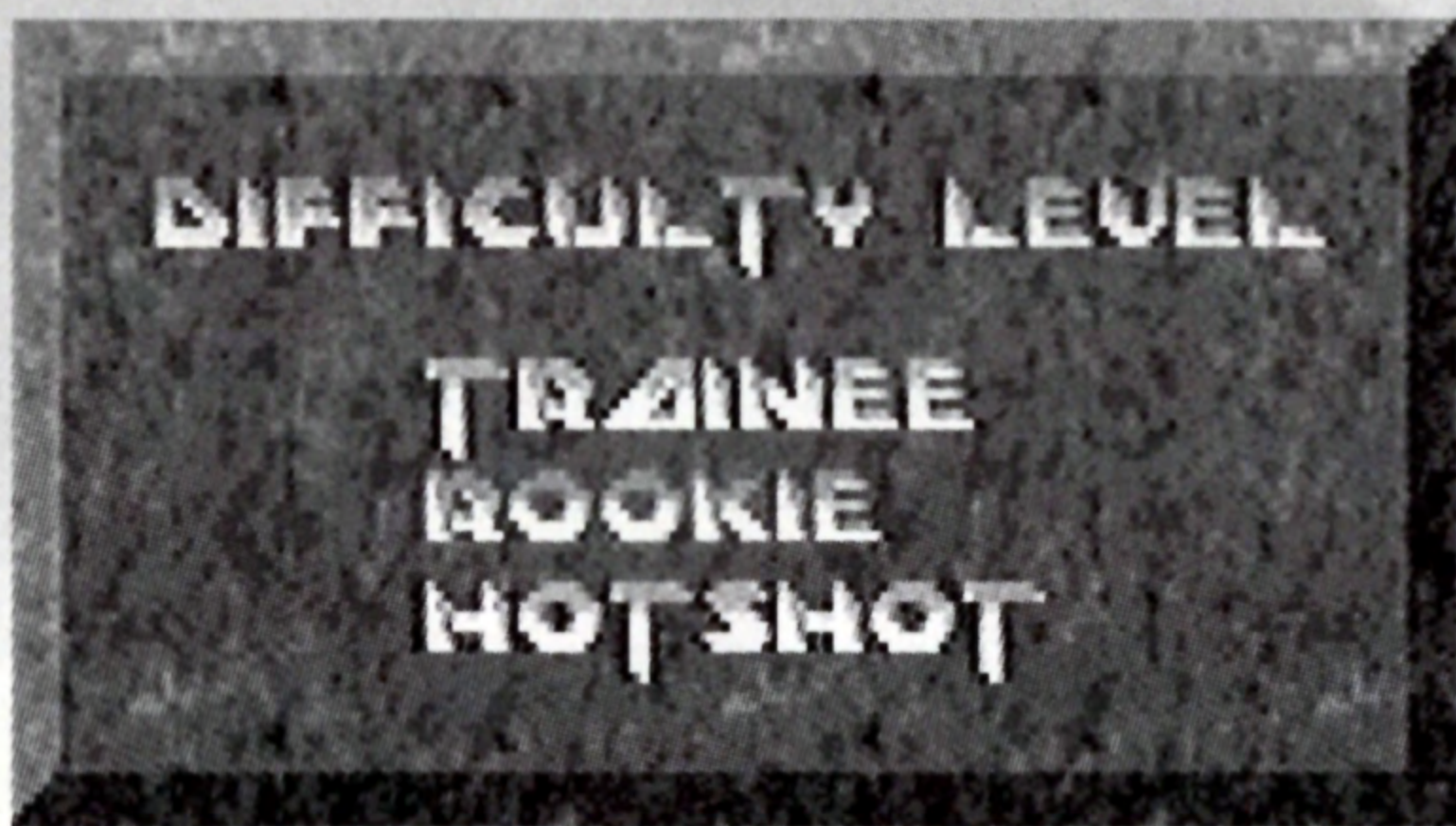

STARTING A NEW GAME

To start a new game, select New Game, then choose your Skill level based on how much action you think you can take. At first you can choose from 3 skill levels: Trainee, Rookie, and Hotshot. As you progress further and complete more worlds and even beat the game you will have the opportunity to play at 2 higher skill levels: Ace and Insane.

Following is a description of the features and gameplay options in Descent Maximum.

When you play Descent Maximum, you'll find yourself thrown into alien worlds populated by deranged robots, determined to destroy you. It is your mission to fight through the robot hordes to each mine's main reactor. Destroying this reactor and escaping is your primary mission!

SCORE

Accumulating enough points will grant you extra lives. Points are awarded for destroying robots, escaping a mine with hostages, and finishing the game with lives to spare. An end-of-level skill bonus is awarded for playing on Hotshot skill level or above.

REAR VIEW

(Only available if assigned a button in your controls configuration.) Allows you to glance out the rear of your ship. Hold down the assigned button to temporarily look out the rear; when you release it you will return to the front view. If you want to switch indefinitely to the rear view, quickly tap the appropriate button.

RECHARGING

At specific sites within every mine there are energy centers that will boost your ship's energy level. Although these centers will only boost your ship's energy level up to 100, it is possible to achieve a maximum level of 200 by collecting "energy packets" that are scattered throughout the mines. These energy centers have distinct gold walls with a sparkling energy field between them. See the "Mine Centers" section for more details.

EXHAUSTING A WEAPON

If you exhaust a weapon, your ship auto-selects the next best one.

YOUR SHIP AS A WEAPON

The objects in Descent Maximum are "physical" objects; you can ram into something with your ship and possibly cause a response. For example, most doors can be rammed or shot open, while hostage doors must actually be fired upon until destroyed. You can conceivably ram something repeatedly to destroy it. If this happens to be a fighting method you've been reduced to, best of luck!

MARKERS

To aid you in your exploration and mapping of each mine in Descent Maximum, it is possible to drop markers. Once you have chosen an appropriate location to drop a marker, press "Select + " (default keys) buttons together. The markers will be named Marker 1 - Marker 9 in the order they were dropped, whenever you (or another player) flies over a marker, that marker's name will be displayed on your HUD (Heads-Up-Display). In single-player games, you may drop up to 9

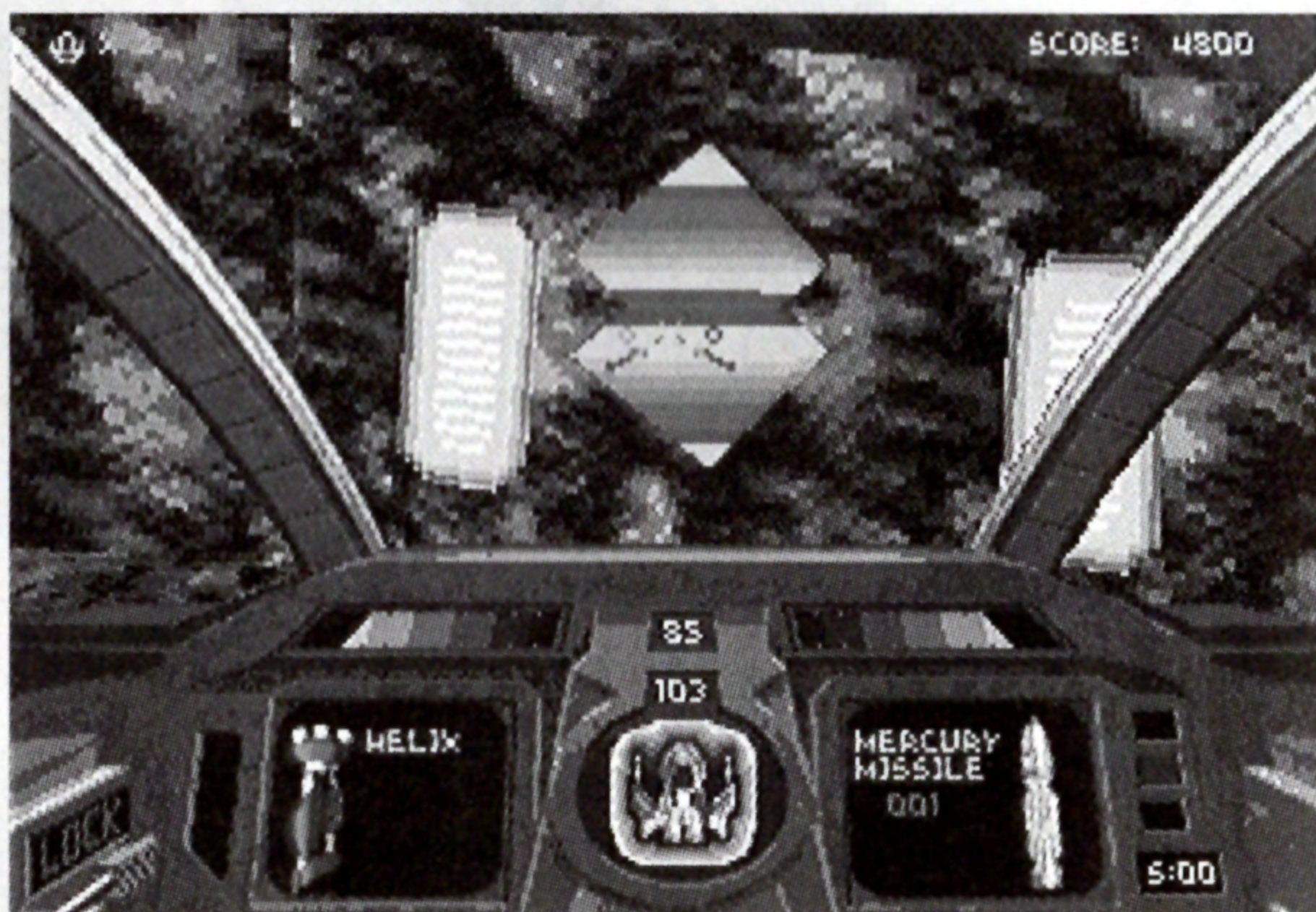

markers. In multiplayer games, each player may drop up to two markers. Markers will appear on the Automap screen as a red dot with the marker number inside.

In the following you'll find brief descriptions of the robots, weapons, powerups, obstacles, and other challenges you'll encounter on the way.

ROBOTS

The mines in Descent Maximum are populated with a dizzying array of robots, nearly all bent on destroying you. They will use a variety of weapons and defenses against you, and use them with varying amounts of intelligence. Some will charge at you directly, others will hide or attempt rear attacks. Some robots will carry weapons you can use, and will drop these when you destroy them, as well as other powerups. Some will even steal your weapons from you!

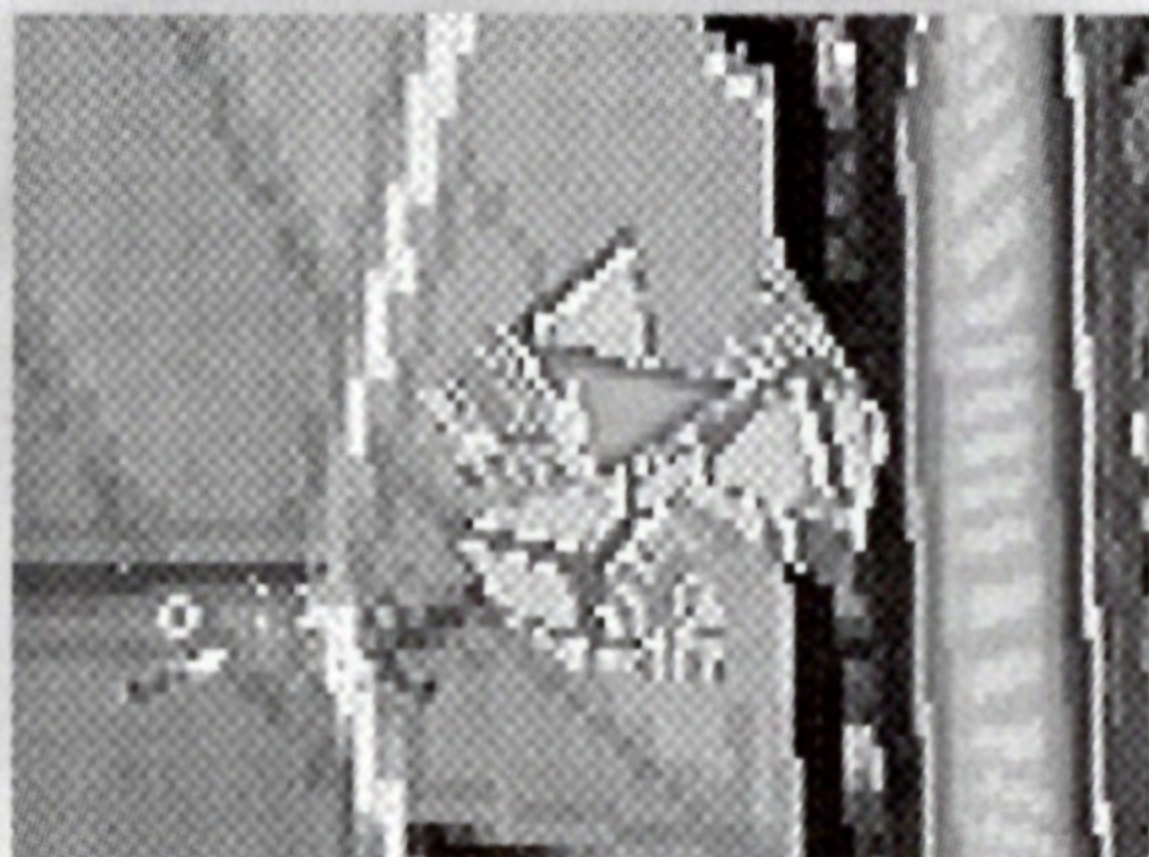

THE GUIDE-BOT

New to Descent Maximum is the Guide-Bot. He's an automated scout robot that has been smuggled into the mines to help you. He's small, blue, and can be found on all of the regular levels - though not on the secret levels. He's usually imprisoned in a little cell near the entrance of each mine. You can choose to free him by blasting open the door to his cell and use his help, or leave him be (you will not be penalized).

IN THE MINES

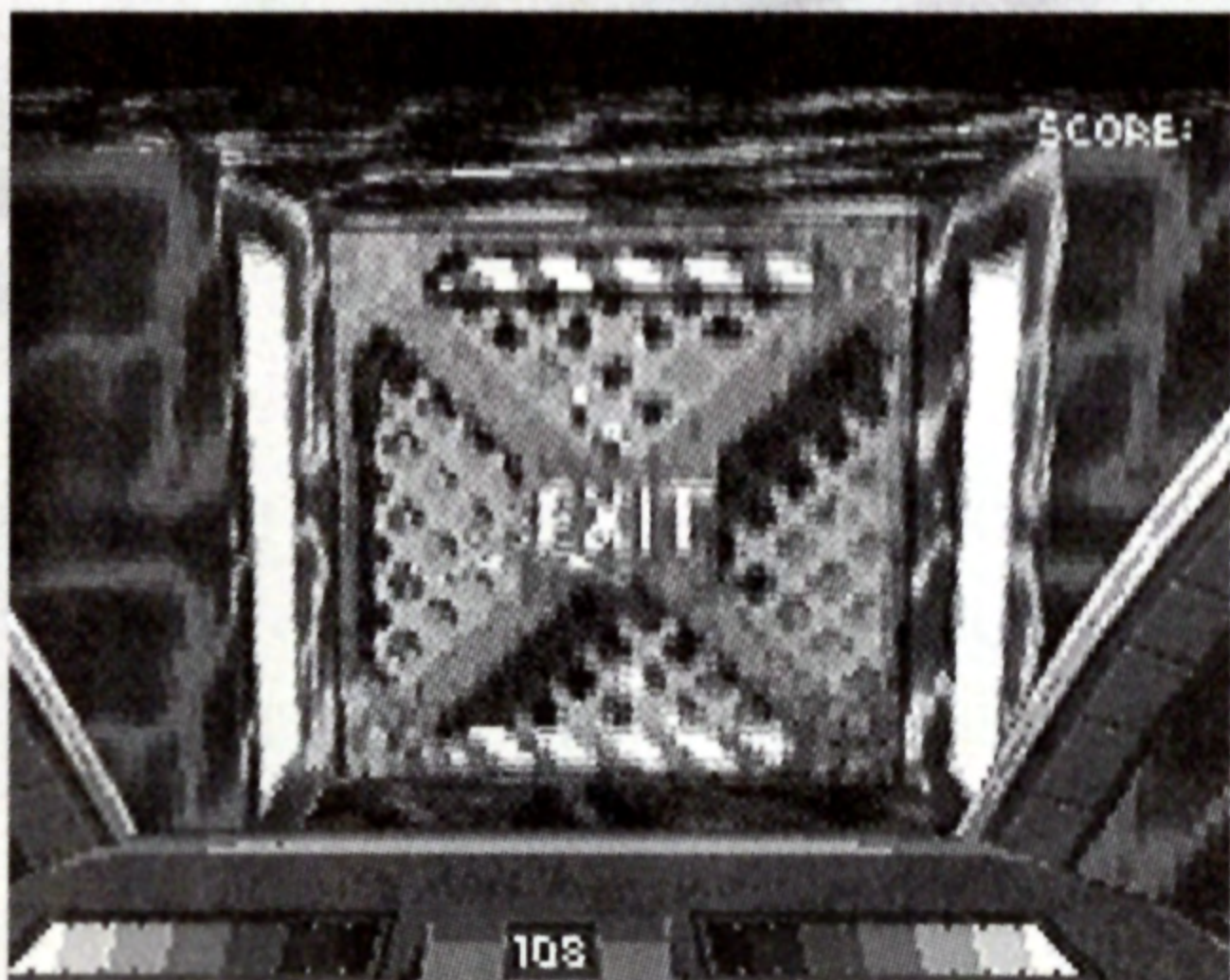

DOORS

There are a variety of doors that can be found in the PTMC mines. Most can be opened by either bumping into them or shooting them. There are some, though, that can only be opened if you have the appropriate access key. Others can only be opened if certain actions are performed or the reactor is set to self-destruct (e.g. the emergency exit). Hostage doors must be destroyed by repeat fire. Some doors are hidden. Certain other doors and secret doors can only be

opened by destroying a control panel. These control panels are located throughout the tunnels along specific walls. When opened, some doors will remain open, while others will close again after a few seconds. Some doors will only open once.

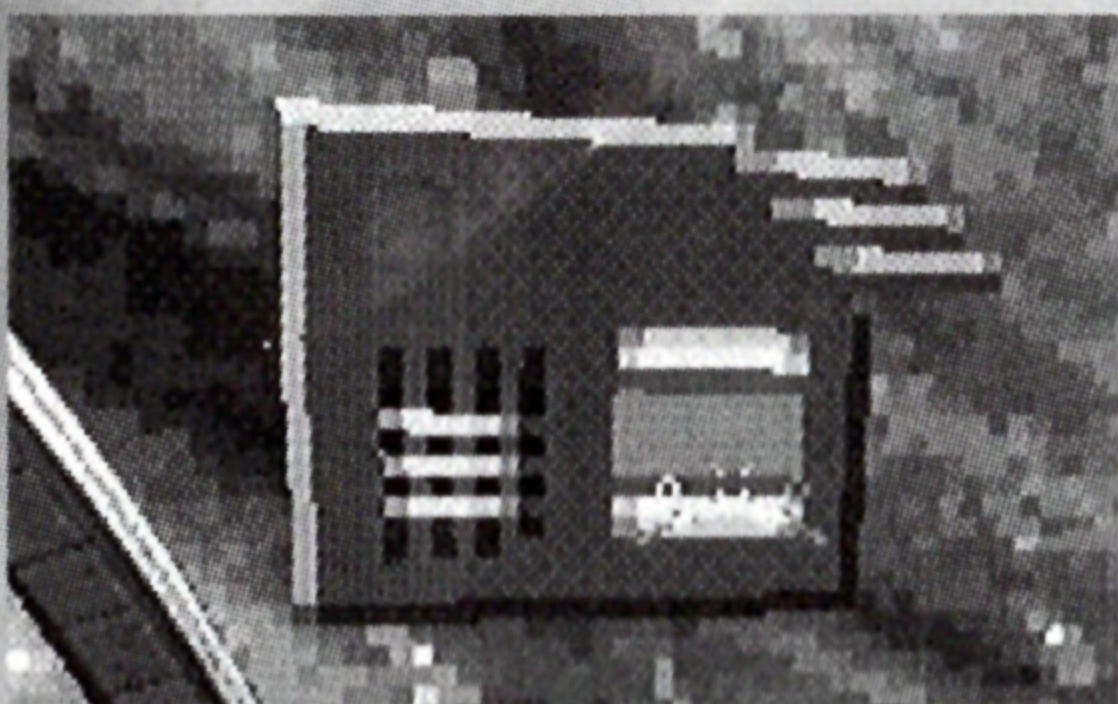

CONTROL PANELS

Glowing control panels can be found throughout the mines in Descent Maximum. These control panels can be destroyed to trigger various events. For example, some control panels may deactivate force fields, remove walls, open doors, or even release hostile robots. Successful completion of some of the mines may depend upon destroying the appropriate control panel.

FORCE FIELDS

Force Fields are energy beams used to block access to parts of the mine. They will repel and damage your ship upon contact, and reflect energy weapons. They have been placed in the mine to guard the keys or powerups. Try to find an alternate path to your goal, or locate a control panel that will deactivate the force field.



HOSTAGES

On some mines you will find blue-uniformed humans who have been imprisoned by the robots. By blasting through their prison doors, you can rescue them from certain death. Bonus points are awarded at the end of each level based on how many hostages you saved. Once you've picked up the hostages, be sure to leave the mine alive. If your ship is destroyed, any hostages on board will be destroyed as well!

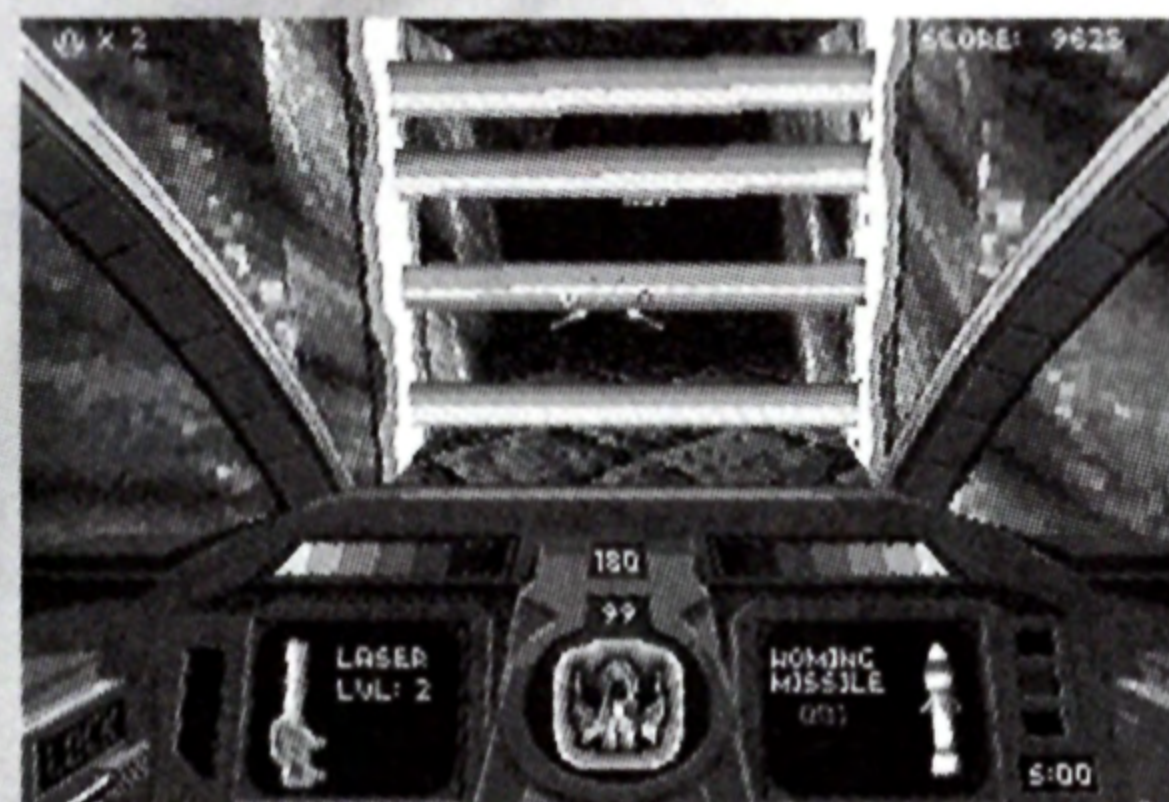

SECRET LEVELS

These levels, accessible only by alternate exits which are triggered open with the destruction of the main reactor, are storehouses for weapons and ship accessories. Although they are usually not heavily defended, they are full of traps and are designed to prevent entrance into the largest caches of weapons.

10

NOTE: Secret levels are not available for multiplayer games.

MINE CENTERS

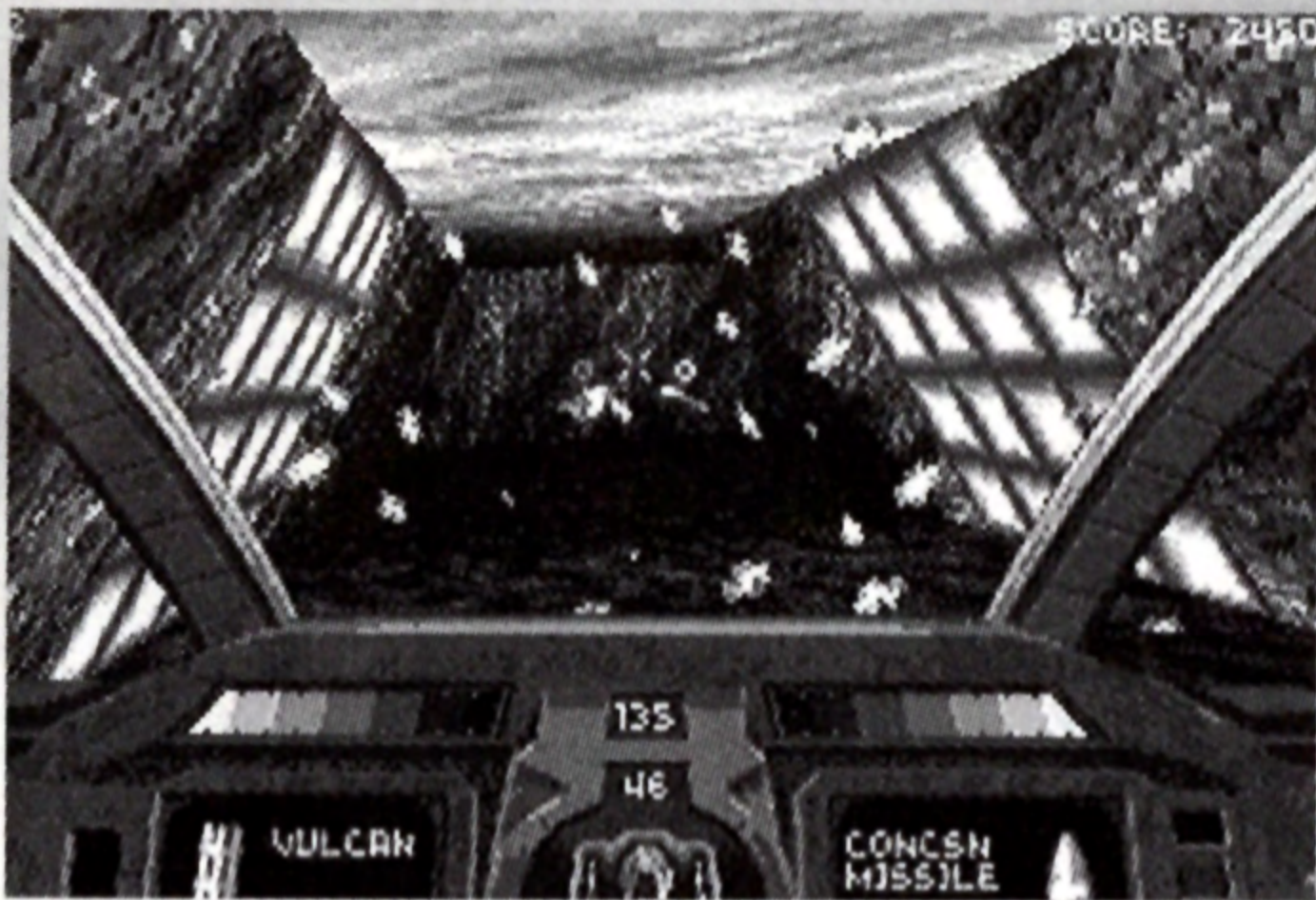

ENERGY CENTERS

At specific sites within every mine there are energy centers designed for “on the fly” replenishing of a robot’s power cells that will boost your ship’s energy level. Although these centers will only boost your energy level up to 100, it is possible to achieve a maximum level of 200 by collecting energy packets that are scattered throughout the mines. These energy centers have distinct gold walls with an energy field between them.

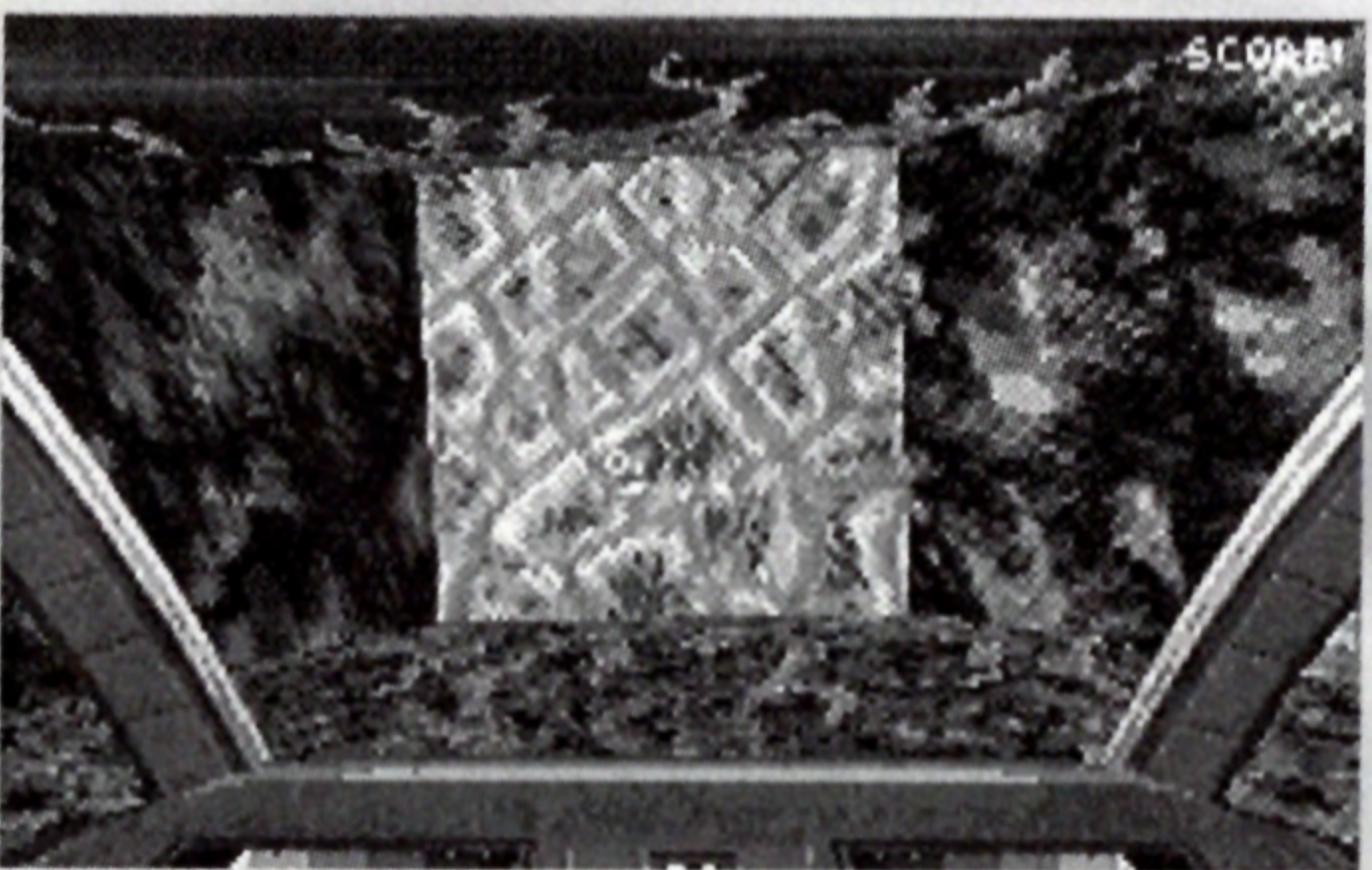

ROBOT GENERATORS

are automated centers that determine a mine’s needs and assemble robots from surrounding minerals and metals. Very dangerous.

MAIN REACTOR

The reactor is the power generator of the whole mine. It’s usually located

in a secluded place away from day-to-day mine mishaps. When the reactor is severely damaged, it will initiate a sequence ending in the destruction of the entire mine. At this point, the emergency exit door for the level will open, and you have a limited amount of time to find the exit and leave the mine.

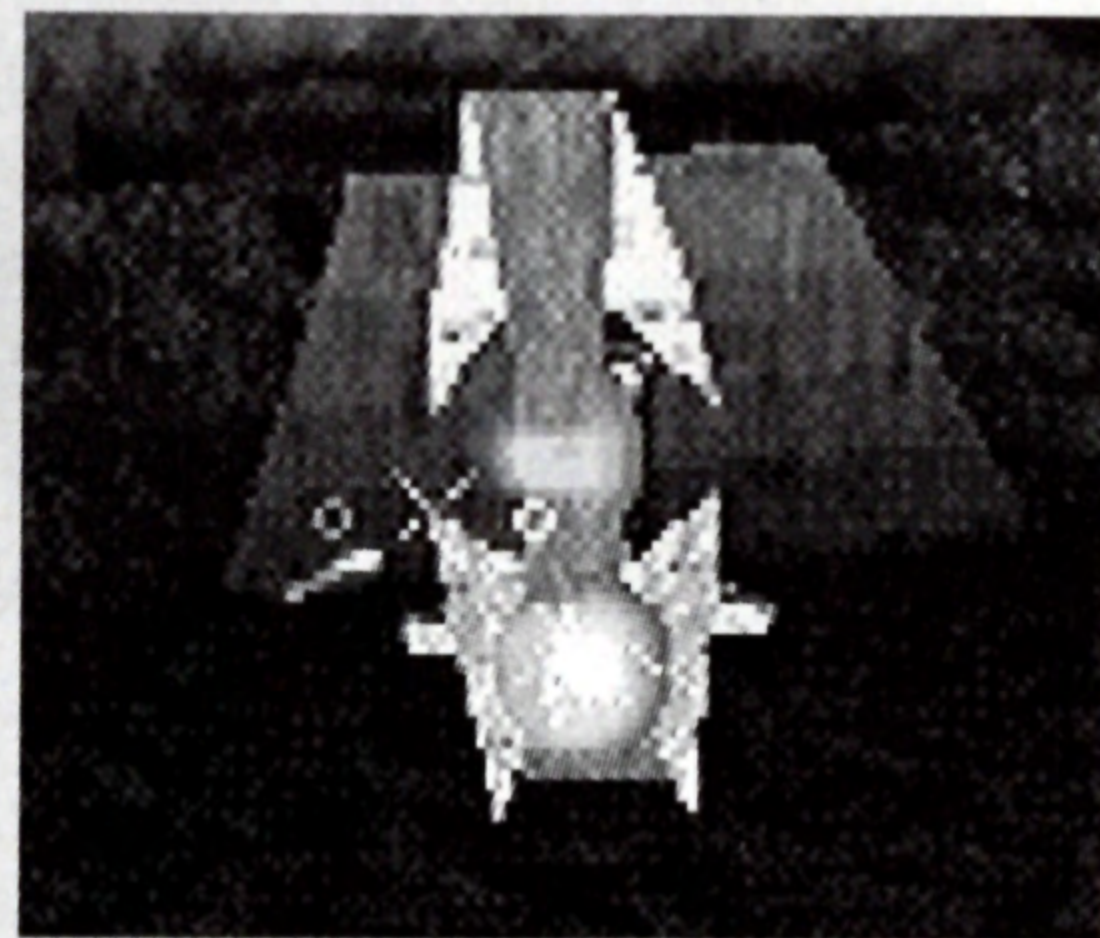

POWER UPS

Throughout the mines are objects you can pick up that give you new weapons, enhance your ship’s capabilities, or replenish your energy or shields.

ACCESS KEYS

These allow you access to the different security levels of the mines. They are color-coded to match the doors they open.

ENERGY BOOST

This will give your energy banks a boost, up to 200 units max. (Energy Centers can deliver recharge up to 100 units.)

SHIELD BOOST

Gives ship's shields a kick. By getting shield power-ups, you can get your shields up to a maximum of 200 units.

CLOAKING DEVICE

Cloaks your ship a limited time. When cloaked, it is hard for robots and other players to see you, and weapons that track (such as the Homing missile) will not be able to lock onto you. Cloaking wears off after 30 seconds.

INVULNERABILITY

Makes your ship invulnerable for 30 seconds.

EXTRA LIFE

Gives you a bonus life.

AMMO RACK

Doubles the holding capacity of all secondary weapons as well as Gauss/Vulcan ammo.

AFTERBURNERS

This gives your ship turbo-boosted thrusters. Afterburners operate off of a separate energy reserve that charges itself from your normal energy banks. When the afterburner button is held down, your ship moves at twice its normal speed, until the button is released or the afterburner charge is exhausted. When the button is released, the afterburner energy will recharge. To activate the Afterburner quickly hit the thrust button twice, to deactivate the Afterburner release the thrust button.

HEADLIGHTS

Helps illuminate nearby mine walls. Also makes your ship more visible to surrounding robots (and players!). The default button to turn your headlight on and off is "Select+△". When you pick up the headlight for the first time it will be on, if you wish you can turn the headlight off.



ENERGY TO SHIELDS CONVERTER

Allows you to divert energy over 100 to your ship's shields. Hold down the transfer button (default is "Select + ○") to activate. Every shield unit costs 2 energy units to convert.

FULL MAP

This will allow you to see the entire mine on your automap. The unexplored areas will show up as blue sections. As you delve further into the mine, the areas you explore will turn white. This will help you find all the secret areas of the mine.

WEAPONS

Your Pyro-GX is equipped with Primary and Secondary weapon systems. There are 10 weapons of each type. When you are first inserted into Level 1, you are equipped with Laser Cannons and Concussion Missiles. As you explore the mines, you will find more powerful weapons and powerups to use. The following is a complete description of each weapon.

Most Primary weapons require energy to use. The Vulcan and Gauss Cannons use ammo that can be found throughout the mines. Secondary weapons are typically missiles found in packs of one or four.

If your currently selected Primary or Secondary weapon is depleted of energy or ammo, your next available weapon will be automatically selected.

Primary weapons are selected using "Select + L1", secondary weapons are selected using default keys "Select + R1". Pressing the selection key will cycle through all your available primary or secondary weapons.

It is possible to drop either a primary or secondary weapon that is currently selected. This can be useful when in a cooperative game, so that your comrade can pick up a weapon he needs but doesn't have. In single-player games, you can drop weapons in strategic locations such as the start of a level, so you'll know where to find them when you need them. It's a good idea to stash some weapons in case you die so you won't have to go virtually unarmed to retrieve your weapons.

(None of the default controller settings have buttons designated for dropping either the primary or the secondary weapons. This will be an option available only after you assign buttons for this function.)

WEAPON CYCLE ORDER

This is the order in which your weapons will cycle:

Primary Weapon

Lasers/SuperLasers
Vulcan Cannon
Spreadfire Cannon
Plasma Cannon
Fusion Cannon
Gauss Cannon
Helix Cannon
Phoenix Cannon
Omega Cannon

Secondary Weapon

Concussion Missile
Homing Missile
Proximity Bomb
Smart Missile
Mega Missile
Flash Missile
Guided Missile
Smart Mine
Mercury Missile
Earth Shaker Missile

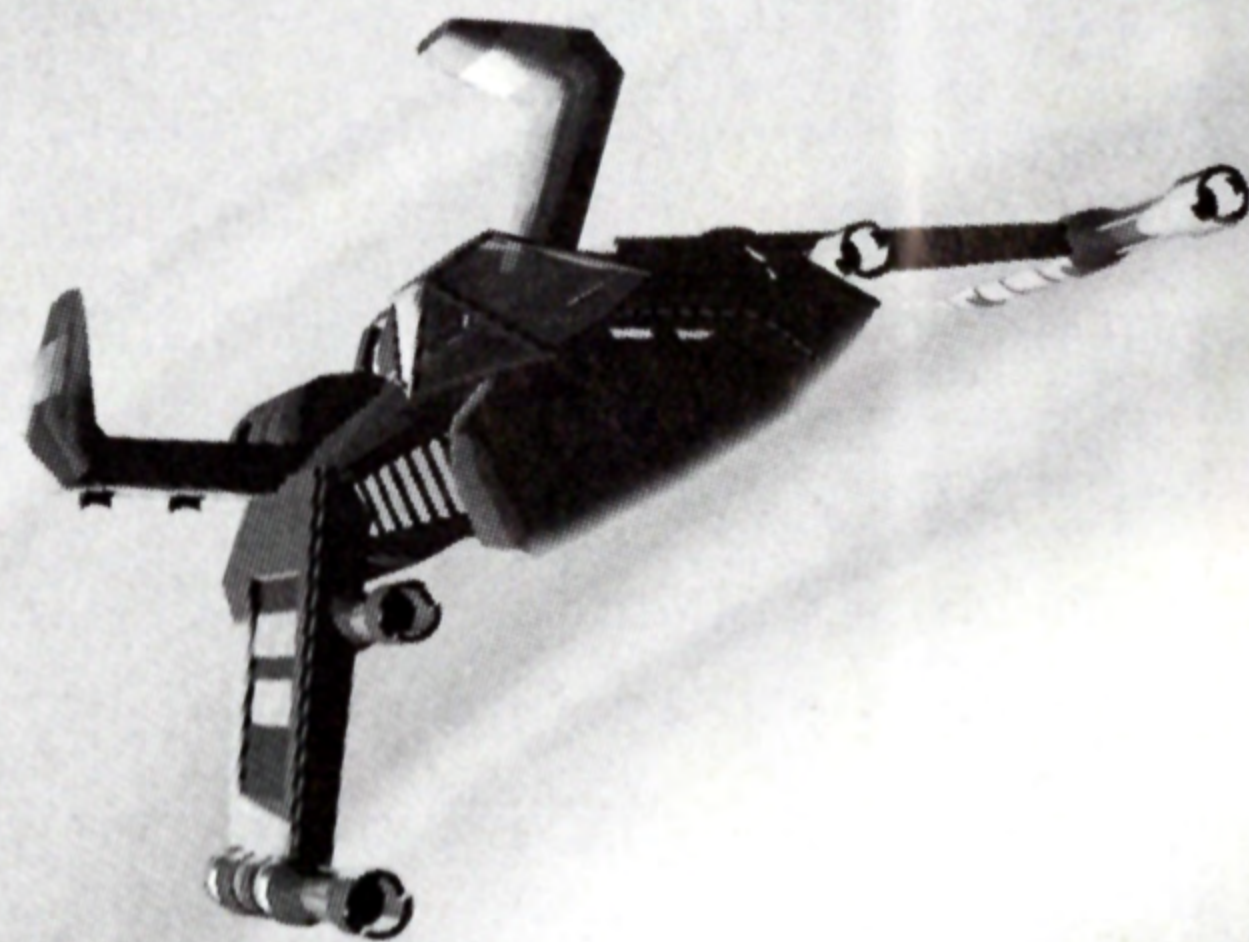

Laser

Laser cannons have six total power levels. The laser powerup will give you the next available level up to level 4.

Super Laser

These beauties will boost your laser above level 4, up to the maximum of 6. The first one you find will raise your laser to level 5. The second will put you up to 6.

Quad Laser

This powerup will modify your existing laser system to fire four bolts instead of the standard two.

Vulcan Cannon

This weapon rapidly fires explosive-tipped shells.

Gauss Cannon

Similar to the Vulcan, this weapon's rate of fire is slower than the Vulcan Cannon, but it fires more massive and devastating bursts of ammo. Uses the same ammo as the Vulcan cannon.

Vulcan Ammo

This gives you ammunition for the Vulcan & Gauss Cannons.

Spreadfire Cannon

Fires a spread of energy at your target.

Plasma Cannon

Fires bursts of supercharged plasma.

Fusion Cannon

Fires destructive blasts of energy directly from the ship's fusion reactor. Holding down the Fire button will charge up the Fusion Cannon until you release it. This can double the damage, but can also damage your ship if you hold it too long.

Helix Cannon

The newest model of the Spreadfire line, this spews destruction over an even wider area.

Phoenix Cannon

A turbo-charged version of the Plasma cannon, the energy bursts from the Phoenix will ricochet off walls.

Omega Cannon

Casts an ultimately powerful beam of energy at your target.

Concussion Missiles

All-purpose dumbfire rockets. Come singly or in packs of four.

Homing Missiles

Same size warhead as Concussion Missiles, these are equipped with a tracking device that can follow a target around most turns. Come singly or in packs of four.

Proximity Mines

These bombs are launched behind your ship, waiting to explode when something gets near. They can be armed as a secondary weapon, or dropped directly by hitting "Select + R2".

Smart Missile

When this missile detonates, it sends bomblets of heated plasma after the surrounding targets.



Mega Missile

Keep out the range of this missile's massive blast.

Flash Missiles

These missiles are armed with a warhead that emits a blinding light upon impact. Any robot or other player's ship within its blast radius will be temporarily blinded by a bright white flash.

Guided Missiles

These missiles are guided by the pilot (using normal flying controls). During flight, if the secondary fire key is pressed again they behave like normal homing missiles.

Smart Mines

More sophisticated versions of the Proximity bombs. When detonated, these spew forth globules of energy that track nearby targets. Can be armed as a secondary weapon, or dropped directly by hitting "Select + R2". The globules of energy released by a smart mine will not track the player or the robot who dropped that mine.

Mercury Missiles

Fast missiles that quickly blast your target to pieces.

Earth Shaker Missiles

The ultimate in mine-rocking destruction, the Earth Shaker creates a huge explosion and sends deadly projectiles at nearby enemies. Treat with respect.

IN-GAME OPTIONS

Press Start at any point in a game to pause the action and enter the Options Menu. You can maneuver through the menu by using the up/down Directional Buttons. Select the following options by pressing "X"; to exit back to your game, press "Start".

RETURN TO GAME

This option is self-explanatory. Select it to return to game.

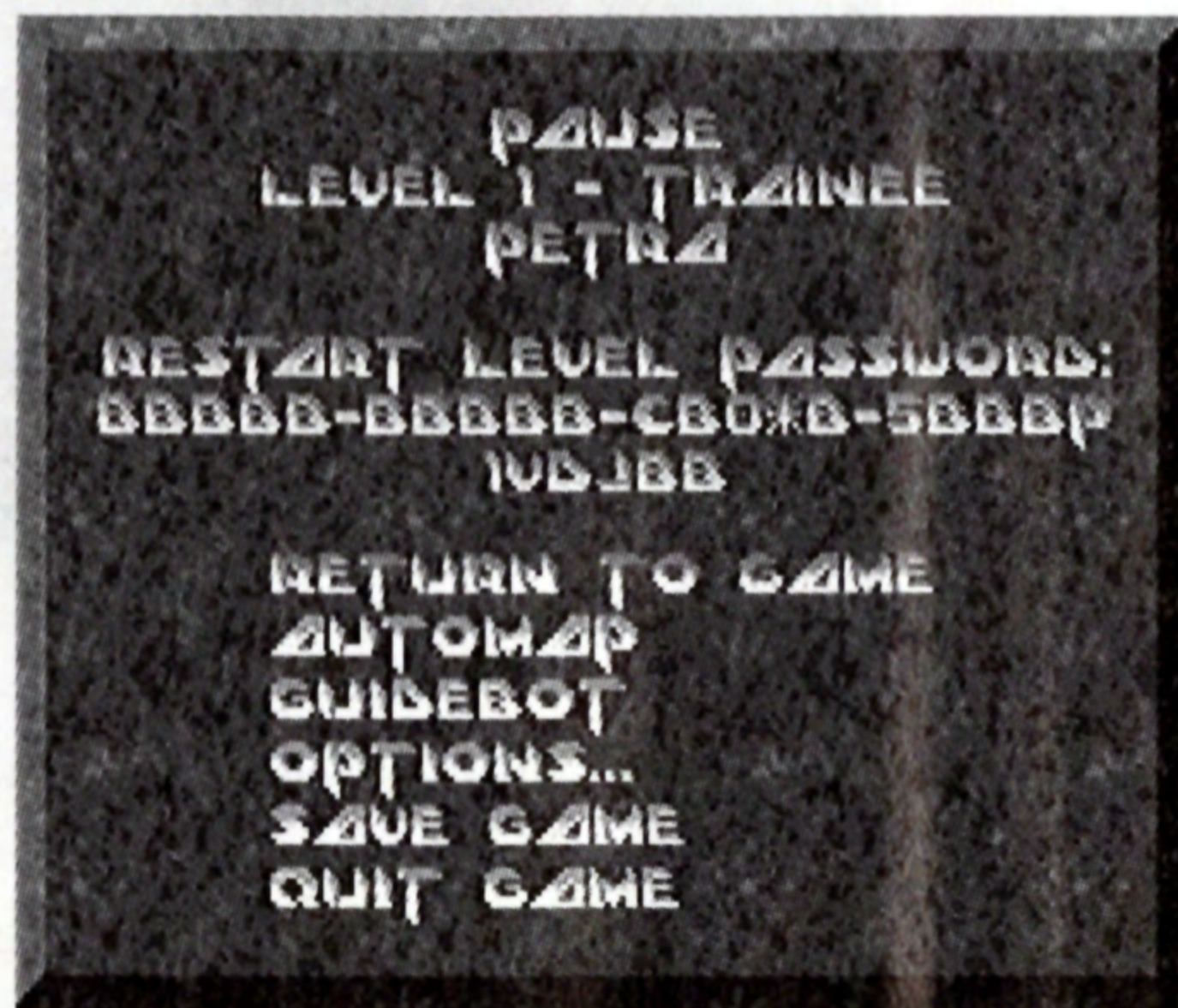

THE AUTOMAP

This option allows you to access the Automap. The Automap keeps track of places you've been. As you move through new territory, your progress is drawn in by the Automap. For help while in the Automap press "Select", to close the Automap, press "Start".

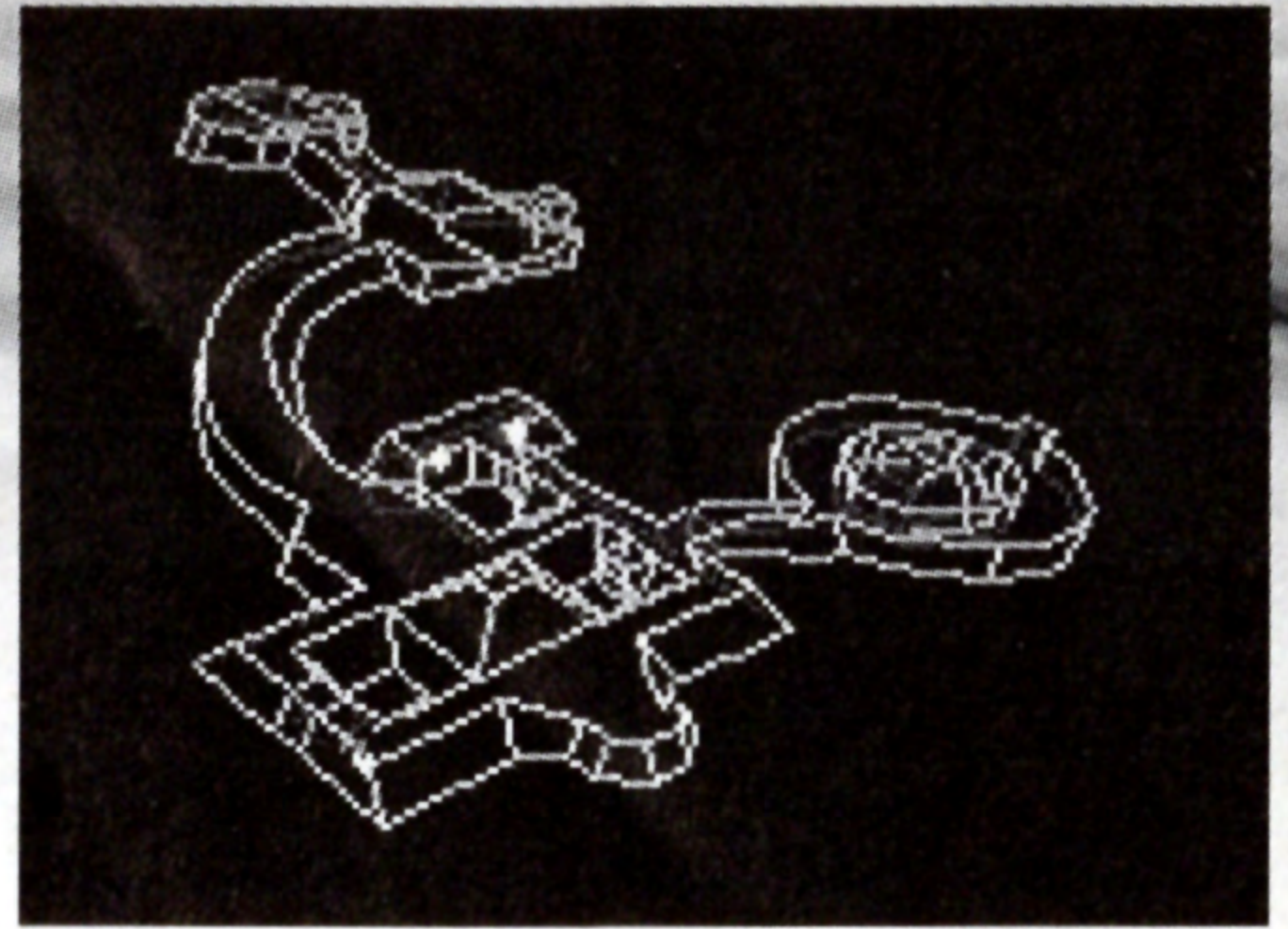

- The center object is your ship. Other green objects are hostages.
- The red area is the Reactor.
- The red, yellow and blue walls are locked doors. These doors require the use of corresponding color-coded access keys for passage.
- Green walls are unlocked doors.
- Yellow areas are energy centers.
- The purple segment is the mine's entrance. Robot Generators are also drawn in Purple.
- Glowing red circles are markers you have dropped.

AUTOMAP CONTROLS:

- To rotate the Map, use the ship turning buttons.
- To move the Map, use the ship sliding buttons.
- To move in and out of the Map, use the forward/reverse buttons.
- To automatically center your ship on the screen, use the primary weapon firing buttons.

If you have acquired the Full Map power-up, you will see the entire map, including areas you have not yet explored. The unexplored areas appear in blue.

OPTIONS

The same basic set of options offered in the Main Menu: Music volume, FX volume, Stereo, Full Screen, Auto-Leveling.

GUIDE-BOT

Once the Guide-Bot has been released, you can use this menu to issue commands for the Guidebot to perform.

The following Guide-Bot commands are available:

- Next Goal
- Find Energy Powerup
- Find Energy Center
- Find Shield Powerup
- Find Any Powerup
- Find A Robot
- Find A Hostage
- Stay Away From Me
- Find My Powerups (Powerups you dropped after dying)
- Find The Exit
- Suppress Messages

Choosing "Suppress Messages" prevents the Guide-Bot's messages from appearing on your HUD. When messages are off, this menu item changes to "Enable Messages", which can be selected to turn messages back on.

Once you issue a command, the Guide-Bot will attempt to follow it until another is issued, or you have achieved the goal. If you issue no commands, the Guide-Bot will first find the keys needed to complete the level, then the reactor, then the exit.

The Guide-Bot will do his best to find his next goal, but he may not be able to if he needs to get through a locked or hidden door. Once you have opened the door, the Guide-Bot will continue on his default or assigned task.

While the Guide-Bot is small and fast, he will die if exposed to enough combat. If you fall far behind the Guide-Bot, he will come back looking for you. He will not open secret or restricted access doors to attain a goal, but will do so in order to find you.

SAVE GAME

Allows you to save your game (this option is only available with a memory card). See "Saving Your Game".

QUIT GAME

Allows you to quit your current game and return to the Main Menu. Use the Directional Buttons to select yes or no and press "X" to make your selection.

SAVING YOUR GAME

There are two ways to save your progress and configuration in Descent Maximum: password and memory card. If you do not have a memory card, then you must save your game using a password. However, to maximize your Descent Maximum experience, we highly recommend using a memory card. With the memory card, you can save and restore your progress quickly at any point. This allows you to progress to higher levels much faster, as there's no need to replay the beginning portion of a level when you restore your game. And you'll never need to reset your configuration or retype that 26-character password.

PASSWORD SAVE FEATURE

Each time you start a new level, a unique password is created that contains the current level number, limited configuration information, and the highest level that you've been on. Start a new level after changing any configuration items in order for them to get saved.

To save your game, press Start while playing to display the Pause menu. The password is displayed near the top of the menu. Write the password down, and check it for accuracy. If you accidentally mistake a B for an 8, you will not be able to enter the password correctly! It is recommended you write it down twice, carefully double-checking it each time.

To restore your game at a later point, select "Enter Password" from the Main Menu. Then, use the Directional Buttons to select each letter. To move to the next character of the password, press the "O" button. To back up, press "□." Once your password is complete, press "X" to accept. If you get an "Invalid" password message, correct any mistakes and re-enter it.

MEMORY CARD SAVE FEATURE

While in the game, make sure you have a card inserted into either memory card slot. Then, select "Save Game" from the Pause menu. You can then select one of five slots to save your game under. If there is no space available, then you must either overwrite an existing saved game or go into the "Erase Files" menu and erase some other files. You must be very careful when erasing files because you can delete information of another game stored on the card. A better solution is to use the memory card manager that is accessed by turning on your PlayStation™ with no CD in the PlayStation™ console to delete files.

To restore a game, select "Load Game" from the main menu. Select Memory Card 1 or 2, then simply move to the saved game that you want to restore and press "X".

LINK CABLE OPERATION

To play against or with another player, install a Link Cable between the two machines, following its own instructions. Start Descent Maximum on each machine and have each player select "Combat Game" from the main menu. The screen will display a message saying "Waiting for remote player" while it validates the connection.

If you wait for more than 15-20 seconds with no connection, press "Start", then "X" after the message to return to the Main Menu. If setup still fails after retrying this procedure a few times, turn off both machines and make sure the cable is connected properly on both of the machines. If it still doesn't work, call our Technical Support line.

Once you get connected, select "Start Game." One of the players will then be asked for the various game parameters:

Mission

This lets you choose which mission file to use. There are two "missions" in Descent Maximum: Operation QFC, The 24 new PlayStation™ only levels and "Extreme Anarchy". These can be played in all modes but are best played in "Cooperative" mode, so that you and your friend can blast away at the robots together. A set of six levels designed for fast and furious action which can be played in Anarchy mode only. These levels are small enough that it is easy to hunt your opponent down.

Level

This can be any valid level for the mission you have loaded. Play will begin on the level selected and can continue to the other levels as play progresses.

Mode

Mode determines the type of game that will be played:

ANARCHY is a player-only battle to the death, where the goal is to hunt down and destroy your opponent.

ROBO-ANARCHY is the same as Anarchy except that, in addition, there will also be robots in the game trying to kill any player they find. The goal is still to score a kill on your fellow player.

COOPERATIVE MODE lets you team up with the other player to destroy all of the robots in the mine and complete the level. The goal: to get the highest score by killing robots, rescuing hostages, and escaping the mine after destroying the level reactor.

Difficulty

Determines several factors, from robot awareness and deadliness to time for mine destruction countdowns. The farther the slider is to the right, the tougher the game.

Once the parameters are chosen, the person starting the game presses Start to begin the action.

Some special rules apply only to Link Cable Descent Maximum games:

- When you fire a secondary weapon, a new power-up of that type is created at random somewhere in the mine, this keeps the total number of secondary weapons in the game constant. If you see a weapon suddenly appear in front of your ship, consider yourself lucky! Replacement power-ups are also created when the effects of an Invulnerability or Cloak power-up wear off. Concussion Missiles are the only secondary weapon not replaced. This replenishment does not occur in cooperative games.

- When you bring up menus, the action does not stop as it does in one-player games. While you're viewing a menu, your ship remains vulnerable to attack by

the other player...and by the robots. It's a good idea to find a quiet spot to hide in if you need to examine the Automap or reconfigure your controls. If you are attacked while in a menu or if the reactor is about to explode, the menu will automatically abort so you can deal with the problem.

- Weapon power-ups are single-use only. When you kill the other player, the weapons he/she is carrying are ejected as power-ups for you to take.

- Other options include "Time Limit" and "Show Opponent".

QUESTIONS & ANSWERS

You should have no trouble running Descent Maximum. Just in case you do have some issues, here are some tips:

Q: Why doesn't my analog joystick respond to the game?

A: Be sure you have the analog joystick plugged in to controller port 1, its mode switch set to Analog, and that it's properly calibrated.

Q: Hey! Why did some of my power-ups disappear?

A: Certain power-ups will remove themselves from the game if they've been around four or five minutes. This only happens to Concussion missiles, Energy power-ups and Shield power-ups dropped by a dead player.

Q: I tried everything but I'm still stuck!

A: Don't panic. Read through the Customer Support section on page 23.

Interplay's Customer Support department will be happy to help with any problems you may have.

DESCENT MAXIMUM

By Parallax Software

Original Design

Mike Kulas, Matt Toschlog

PlayStation Programming

Christopher Pfeiffer, John Slagel

Level Design

Dan Wentz, Jason Whiteside,
Peter 'Overkill' Han, Bill Hamilton

Robot Design

Jason Whiteside, Adam Pletcher,
Doug Brooks, Mark Dinse, Dan Wentz

2D Artwork

Adam Pletcher, Jason Whiteside,
Doug Brooks, Dan McMillan, Mark Dinse

Producer

Craig Derrick

Programming

Matt Toschlog, Mike Kulas,
Jason Leighton, Mark Allender,
Che-Yuan Wang, Samir Sinha,
Robert Huebner

Cinematic Sequences

Adam Pletcher, Doug Brooks

Sound Effects

Doug Brooks, Dan Wentz, Eric Brosius

Writing

Ryan Garcia

Testers

Jeremey Bernal, Rob Wentz

Administrative Support

Laurie Ford, Misty Goodman

Visit **Parallax Software** at:

[HTTP://WWW.PXS SOFTWARE.COM](http://www.pxssoftware.com)

FOR INTERPLAY

Produced by

Raphael Hernandez

Line Producer

Kihan Pak

AUDIO CREDITS

CD Music

Type O Negative

"Haunted" written by **Peter Steele**

Performed by **Type O Negative**

Courtesy of Roadrunner Records

Ogre of Skinny Puppy and Mark Walk
Ogre appears courtesy of American
Recordings

Brian Luzietti, Mark Morgan,
Larry Peacock, Johann Langlie,
Ron Valdez

Music Mastering

Tom Baker at Future Disc

Music Assistance

Leslie Spitzer, Brad Lee Scott,
Tim "Q" Wiles

Gameplay SFX

Gregory Allen, Larry Peacock
Charles Deenen, Steven von Kampen

EFX Systems

Soundelux Media Labs

SFX and Voice Mastering

Craig Duman

Cinematic Soundeffects

Charles Deenen

Cinematics mixed at

EFX systems in Dolby(tm) Surround

Voice Editing

Chris Borders, Sergio Bustamante,
Craig Duman

Cinematic Score

Peter Rodder and Andy Weiner
for Four bars entertainment

Voice Director

Melodee M. Spevack

Voices

George Del Hoyo, Walter Burr, Mari Devon
Chris Borders, Sergio Bustamante,
Shanna San Paolo, Michael McConnohie

Voice Recording Studio

WBR, Burbank

Voice Post-production

Charles Deenen

Music Supervision

Brian Luzietti, Charles Deenen

3D Audio Processing

Spatializer

Video Demon

Bill Stoudt

Dolby and the double-D symbol are
trademarks of **Dolby Laboratories
Licensing Corporation**

QA CREDITS

Director of QA

Chad Allison

Assistant Director of QA

Colin Totman

QA Technician

Steve Cabiness

Lead Tester

Derek Bullard

Testers

Richard Barker, Steve Baldoni,
Michael Krueger, Arlen Nydam,
Jim Dunn, Savina Greene

Stop by Interplay at

[HTTP://WWW.INTERPLAY.COM](http://www.interplay.com)

Special Thanks To:

Sandy and Randy Jedryczka, Michael O'brian,
Tami and Michael Wentz, Johnnie Chamberlin-
Brooks, Carol Breznai for all the love and support.
Maurice Morgan, Michelle French, Achim
Stremplat, Andy Tanguay, Brad Lamont, Jim
'Nephilim' Boone & Kihan 'Scrub' Pak For arctic
bug hunting, Bev's Caribbean Kitchen, Angelo's,
Victoria Green, Leigha Lafleur, Irene Sakellarakis,
Robin Ralph, Tami & Michael Wentz, Johnnie
Chamberlin, Ed & Fran, Fiona & Emily, Champion
House, Bob & Rover, Special Agent Dana Scully

CUSTOMER SUPPORT

If you have any questions about this, or any other Interplay product, you can reach our Customer Service/Technical Support Group at: Interplay, 16815 Von Karman Ave., Irvine, CA 92606 Attn.: Customer Service. Customer Service is available 24 hours a day through our Automated Customer Service system, with a Customer Service representative available during normal (Pacific time) business hours at (714) 553-6678. Please have your system information available, or better yet, try to be at your PlayStation™. The more detailed information you can provide our support personnel, the better service we can provide you.

Hintline

Hints are available for this game. You can reach our hintline at 1-900-370-PLAY (1-900-451-6869 in Canada). For this service, the charge for the first minute is \$1.25; \$.75 for each additional minute. For Canada, these charges will be in Canadian dollars. All hint questions must be directed to this "900" service. No hints will be given on our Customer Service lines. You must have a touchtone phone to use this service. The hintline is open 24 hours a day. All long distance charges are included in these prices. Callers under the age of 18 must get parental permission before calling the hintline. The hintline is only available in the U.S. and Canada. Charges subject to change without notice.

If you have a modem, you can reach us at the following: The Interplay BBS: We have a 24-hour, 7-day a week multiline BBS available for customer questions, support and fixes. The number is 714-252-2822. Modem settings are 300-28.8k Baud, V.32bis, V.42bis, 8-N-1. You also may contact our BBS over the Internet. Telnet to bbs.interplay.com. This is a free service (excluding toll charges).

America Online: You can E-mail Interplay Customer Support at IPTECH. To reach our Customer Support board in the Industry Connection, press CTRL-K for "Go To Keyword". Then type INTERPLAY in the Keyword window. In addition to reading and leaving messages, you can download fixes and demos from the "Software Libraries".

CompuServe: We are available for IBM and compatible on-line support. We are located in the Game Publishers B Forum, type GO GAMB PUB at any "!" prompt. Then select "Section 4" for Interplay Productions. You can leave technical support questions there. You can also download fixes and demos from Library 4 in GAMB PUB. The best place for game play hints about our games is in the GAMERS forum. If you are not already a CompuServe member, you can call CompuServe toll-free at 1-800-524-3388 and ask Representative #354 for a free introductory membership and a \$15 usage credit. For game play hints look in the Gamer's Forum (GO GAMERS). Besides technical support for Interplay products, CompuServe offers many other services, including communications, reference libraries, hardware and software support, travel, games and much more.

PRODIGY Interactive Personal Service: You may send mail directly to us. Our ID is "PLAY99B".
Internet: You can reach Interplay by sending Internet E-mail to "support@interplay.com". Many Interplay demos and patches are available at Internet FTP sites. To visit our World Wide Web site, point your browser to: "<http://www.interplay.com>" or you may ftp to [ftp.interplay.com](ftp://ftp.interplay.com).

LIMITED WARRANTY

INTERPLAY LIMITED 90-DAY WARRANTY

Interplay warrants to the original purchaser of this Sony PlayStation™ product that the compact disc on which the software programs are recorded will be free from defects in material and workmanship for 90 days from the date of purchase. If the compact disc is found defective within 90 days of original purchase, Interplay agrees to replace, free of charge, any product discovered to be defective within such period upon receipt at its factory service center of the product, postage paid, with proof of the date of purchase. This warranty is limited to the compact disc containing the software program originally provided by Interplay and is not applicable to normal wear and tear. This shall be void if the defect has arisen through abuse, mistreatment, or neglect. Any implied warranties applicable to this product, including warranties of merchantability and fitness for a particular purpose are disclaimed. Interplay disclaims all responsibility for incidental or consequential damages.

Some states do not allow limitations as to how long an implied warranty lasts and/or exclusions or limitations of incidental or consequential damages so the above limitations and/or exclusions or liability may not apply to you. This warranty gives you specific rights, and you may also have other rights which vary from state to state.

LIFETIME WARRANTY

If the compact disc should fail after the original 90-day warranty period has expired, you may return the software program to Interplay at the address noted below with a check or money order for \$15.00 (U.S. currency), which includes postage and handling, and Interplay will mail a replacement to you. To receive a replacement, you need to enclose the original defective compact disc in protective packaging accompanied by: (1) a \$15.00 check or money order, (2) a brief statement describing the defect, and (3) your return address. If you have a problem with your software, you may wish to call us first at (714) 553-6678. If your compact disc is defective and a replacement is necessary, U.P.S. or registered mail is recommended for returns. Please send the defective disc(s) only (not the box) with a description of the problem and \$15.00 to:

Warranty Replacements
Interplay Productions
16815 Von Karman Avenue
Irvine, California 92606

COPYING PROHIBITED

This software product and the manual are copyrighted and all rights are reserved by Interplay Productions and are protected by the copyright laws that pertain to computer software. You may not copy the software except that you may make one copy of the software solely for backup or archival purposes. You may not loan, sell, rent, lease, give, sub license, or otherwise transfer the software (or any copy). You may not modify, adapt, translate, create derivative works, decompile, disassemble, or otherwise reverse engineer or derive source code from, all or any portion of the software or anything incorporated therein or permit or encourage any third party to do so.

INTERPLAY'S WORLD WIDE WEB SITE

Welcome to the Interplay Web! As a company dedicated to providing innovative, high-quality interactive entertainment software, we are always striving to stay as close as possible to the leading edge of technology. This Web site is the latest example of our ongoing effort to provide a wealth of information and opportunities to you.

As a company of fanatic gamers, we love the idea of gamers all over the world tapping into cyberspace to see, touch and feel our latest games. No hype, no marketing campaign; just great games. To make it work, our goal is to keep this site fresh and new, to make it a place where you can tell US what you like about our games... and what you don't like about them. So use the feedback options on these pages and sound off.

Enjoy your visit in our Web site, explore all the different areas we have to offer, and come back soon. Check us out in the weeks and months ahead; we will be introducing new and exciting areas for you to experience.

Once again, welcome.

Brian Fargo

HOW TO GET THERE

Interplay's World Wide Web site is an Internet service designed to give you the latest information about Interplay and our products.

The site features our demos, upgrades, product information and ordering information.

From your Internet account, point your favorite browser to: **<http://www.interplay.com>**

The screenshot shows a Netscape browser window displaying the Interplay website. The browser's address bar shows the URL <http://www.interplay.com/index.html>. The website layout includes a navigation menu at the top with links for 'The Games', 'Support', 'Ordering', 'Contests', 'What's New', 'Hints', 'Previews', 'Sign-In', 'Coming Soon', 'Patches', 'FTP Site', and 'Site Index'. A 'MAX' logo is visible in the top right corner. The main content area features a welcome message from Brian Fargo, followed by a list of game categories and their corresponding links: 'The Store', 'The Interplay RAG', 'Online Games', 'Interplay's Games', 'Coming Soon', 'What's New', 'Shattered Steel', 'Descent', 'Contests', 'JETFIGHTER III', 'Support', 'Hints', 'Previews', 'Interplay Profile', 'Jobs', 'Press Box', 'Rip Interplay.com', 'Cool Sites', 'Webmaster's Page', 'Japanese Pages', and '0 of The Demos'. The bottom of the page contains logos for 'BY GAMERS' and 'FOR GAMERS', along with a copyright notice for Interplay Productions, Inc. in 1996.

COMING SOON

CLAY FIGHTER EXTREME™

Bad Mister Frosty is back with a new generation of Clay Fighters ready to "fire" you up with combo moves and morphing attacks. With its revolutionary interactive 3D breakthrough backgrounds, Clay Fighter



Extreme is sure to knock you out!



GET READY TO CRRRUMBLE!



The most animated game in the world with...

the most destructive weapon controlled by...

the most unexpected leader in...

the most alive world ever created.

Wild 9 — it's bigger than you think.



Interplay Productions • 16815 Von Karman Ave. • Irvine CA 92606

© 1997 Parallax Software. All rights reserved. Descent, Maximum, and Interplay are trademarks of Interplay Productions. All rights reserved. PlayStation and the PlayStation logo are trademarks of Sony Computer Entertainment Inc. All rights reserved. All other trademarks are the property of their respective owners.

Licensed by Sony Computer Entertainment America for use with the PlayStation game console. PlayStation and the PlayStation Logos are trademarks of Sony Computer Entertainment Inc. The ratings icon is a trademark of the Interactive Digital Software Association. Manufactured and printed in the U.S.A. THIS SOFTWARE IS COMPATIBLE WITH PLAYSTATION GAME CONSOLES WITH THE NTSC U/C DESIGNATION. U.S. AND FOREIGN PATENTS PENDING.

